



**DAC
MEDITECH**

WE INNOVATE HEALTHTECH



For visit Website



E



N



T

**OTOLOGICAL MIDDLE EAR PROSTHESIS
OTOLOGICAL VENTILATION TUBES
RHINOLOGY PRODUCT
PVA DRESSINGS**



About Us

.....
We Provide Best ENT, Implants & Equipments
.....

Why Do We Exist?

At DAC Meditech, We believe in challenging the fast-changing ENT instruments, Equipments & Implants industries. We believe in thinking differently.

How We Do?

We challenge the fast-changing world by providing world-class ENT instruments, Equipments & Implants to the Doctors who believe in bringing the change in the society by human efforts.

What We Do?

We just happen to manufacture the great ENT Instruments, Equipments & Implants to revolutionize the medical industry.

OTOLOGICAL MIDDLE EAR PROSTHESES

Tita-prosthese type Partial Vario Campana



Shaft Diameter: 0.30mm
 Functional Length (L): 5.00mm to 1.75mm
 Disk Diameter: 3.00mm

Tita-prostheses type Total Vario Cask

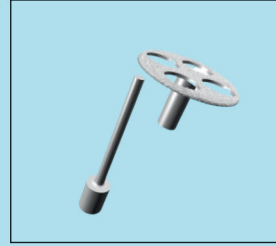

Shaft Diameter: 0.30mm
 Functional Length : 7.00 to 3.00mm
 Disk Diameter: 3.00mm



PTFE Partial Prosthesis (PORP)



Shaft Diameter OD/ID: 2.00/1.20mm
 Functional Length: 5.00 to 2.00mm
 Flange Diameter: 4.00mm
 ETO Sterilized

PTFE Total Prosthesis (TORP)



Shaft Diameter: 1.00 mm
 Functional Length : 7.00 to 3.00mm
 Flange Diameter: 3.00mm
 ETO Sterile



Super Titanium Vario Piston type Loop



Shaft Diameter:: 0.4mm
 Functional length:7.00 to 3.50mm
 Flat Band Loop
 ETO Sterilized

Super Tita-PTFE Vario Piston type Loop



Shaft Diameter: 0.4mm
 Functional length:7.00 to 4.00mm
 Flat Band Loop
 ETO Sterilized



PTFE Stapes Piston



Functional length:3.50 to 6.00mm
 Loop Inner Diameter: 0.60mm
 ETO Sterilized
 Piston Dia:-
 0.40
 0.50
 0.60

Tita-Prostheses Piston type Loop



Shaft Diameter: 0.4mm
 Functional length:7.00 to 3.50mm
 Flat Band Loop
 ETO Sterilized

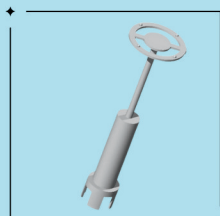

Titanium Universal ear prosthesis (TORP-PORP)
 (Titanium-PTFE)
 Shaft Dia: 0.3mm
 Disk Dia: 0.3mm {L:7.00mm} Connector Dia:
 0.8mm

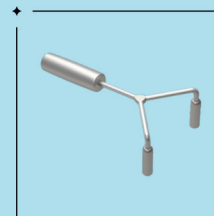

Malleus replacement prosthesis
 Material Titanium
 Dimensions
 0.8mm-3.00mm
 Length -6.25

OTOLOGICAL MIDDLE EAR PROSTHESES

FLUOROPLASTIC VENTILATION TUBES

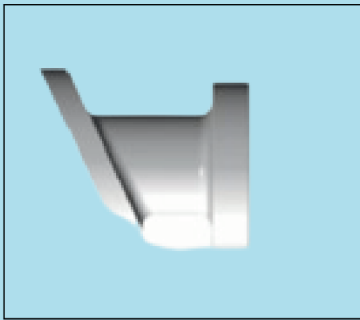

Armstrong
ID: 1.14
IFD: 3.50
OFD: 3.20
TL: 3.80

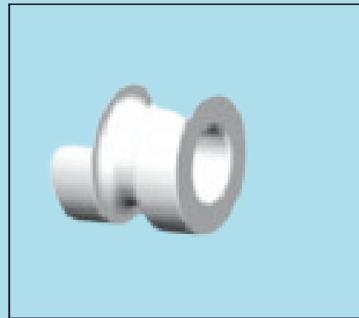

Modified danalson
ID: 1.14
IFD: 3.50
OFD: 3.20
TL: 2.30

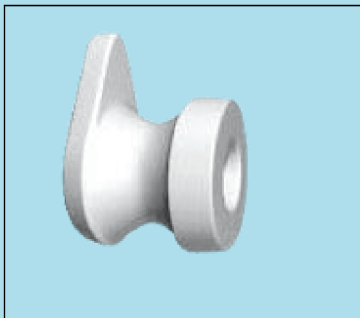
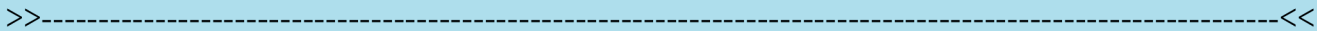

SHAH
ID: 1.14
IFD: 3.40
OFD: 2.30
TL: 2.40



Mini Shah
ID: 0.76
IFD: 2.20
OFD: 1.50
TL: 1.50

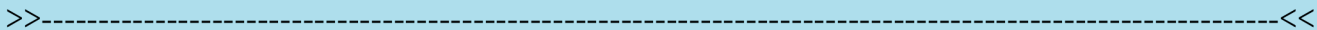

Shepard
ID : 1.14
IFD: 2.40
OFD: 2.40
TL: 2.20



Bexter Bevel Bobbin
ID : 1.27
IFD: 2.80
OFD: 2.80
TL: 2.20

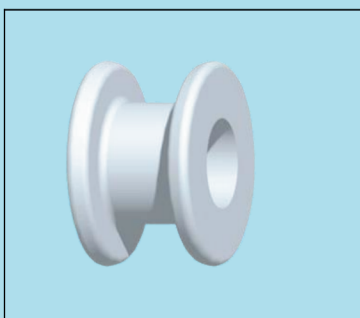
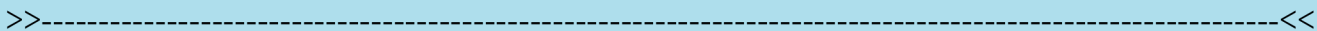

Collar Button
ID: 1.14
IFD: 2.30
OFD: 2.30
TL: 2.15

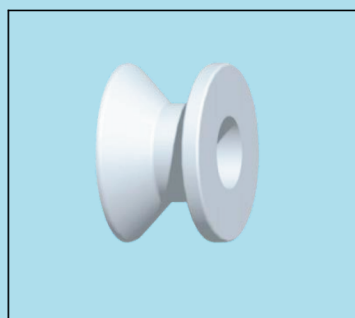

Bevel Bobbin
ID: 1.14
IFD: 2.80
OFD: 2.80
TL: 1.70

OTOLOGICAL MIDDLE EAR PROSTHESES

SILICONE VENTILATION TUBES

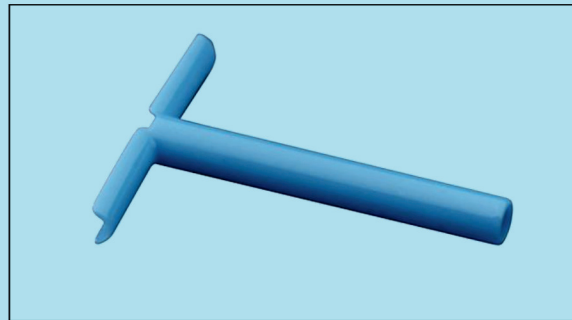

PRODUCT NAME T	ID	OFD	FW	TL
Tube	1.14	1.70	8.00	6.0
T Tube	1.14	1.70	8.00	9.00
T Tube	1.14	1.70	8.00	12.0

>>-----<<<



>>-----<<<

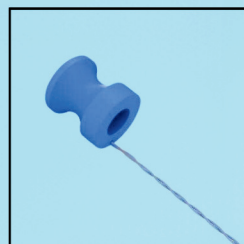
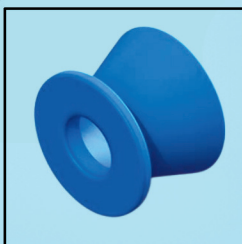

>>-----<<<

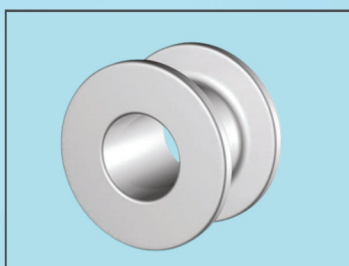

RHINOLOGY PRODUCT



PRODUCT NAME	SIZE
Nasal Septal button	3cm
Nasal Septal button	5cm

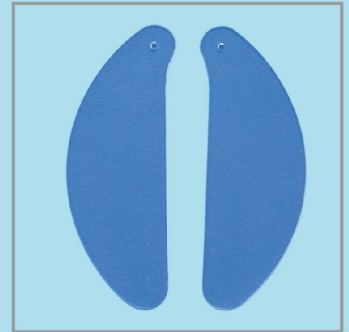

Pre cut nasal septal splint

>>-----<<



PRODUCT NAME
Nasal Airway Splint Standard
Nasal Airway Splint Large
Bi-Valve Splint Small
Bi-Valve Splint Medium
Bi-Valve Splint Large

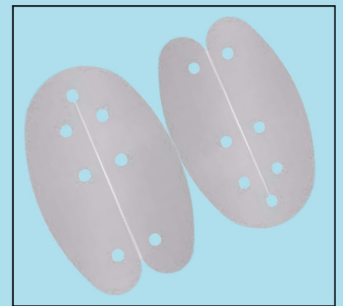

>>-----<<

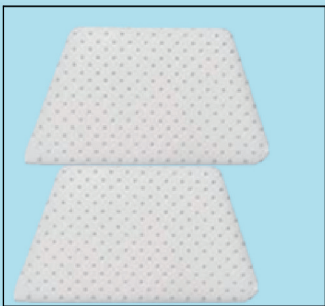

PRODUCT NAME
Thermoplastic Splint Small
Thermoplastic Splint Medium
Thermoplastic Splint Large
Thermoplastic Splint Custom-Cut
Aluminum Splint Small
Aluminum Splint Medium
Aluminum Splint Butterfly

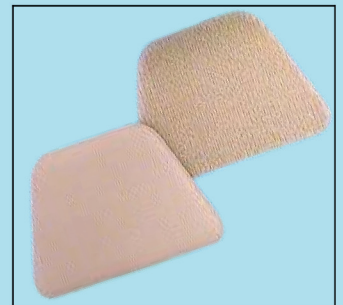

>>-----<<



SIZE(mm)	THICKNESS
55x75	3.00mm
55x75	5.00mm
38x50	0.13mm
55x75	0.25mm
55x75	0.5mm
55x75	1.0mm

PVA NASAL AND EAR DRESSING

PVA NASAL AND EAR DRESSING
Gamma Sterilized
Material: Medial Grade Polyvinyl Alcohol

Standard Nasal Dressing

PRODUCT NAME	SPECIFICATION	DESCRIPTION
Nasal Dressing	4.5cmx1.5cmx2.0cm	With string
Nasal Dressing	4.5cmx1.5cmx2.0cm	With string & tube
Nasal Dressing	8.0cmx1.5cmx2.0cm	With string
Nasal Dressing	8.0cmx1.5cmx2.0cm	With string & tube

Epistaxis Nasal Dressing

PRODUCT NAME	SPECIFICATION	DESCRIPTION
Nasal Dressing	10cmx1.5cmx2.0cm	With string
Nasal Dressing	10cmx1.5cmx2.0cm	With string & tube



Ear PVA Dressing

PRODUCT NAME	SPECIFICATION	DESCRIPTION
Ear Wick	9mmx 15mm	No string
Ear Wick	12mmx15mm	No string



DAC MEDITECH

WE INNOVATE HEALTHTECH



For visit Website

To offer everyone who seeks quality and service the best service available in the healthcare sector.



**B-246, Park Town Commercial Complex, Aditya
World City, NH24, Ghaziabad, UP 201002**



contact@dacmeditech.com



+91 9818587422, 9350143545



www.dacmeditech.com